

Anbauanleitung: Dachträger Halterset für
Dacia Duster III mit modularer Reling

AL: 2403-05

Best.Nr.: 50-T1101010

Montagezeit: ca. 90 min.

Hier sehen sie die fertig montierte Plattform .

Bevor sie mit der Montage beginnen, lesen sie bitte diese Anleitung und das Benutzerhandbuch der Plattform gut durch.

Bitte prüfen Sie die Schraubverbindungen in regelmäßigen Abständen und ziehen Sie sie gegebenenfalls nach!

Here you can see the fully assembled platform.

Before starting assembly, please read these instructions and the platform user manual carefully.

Please check the screw connections at regular intervals and retighten them if necessary!



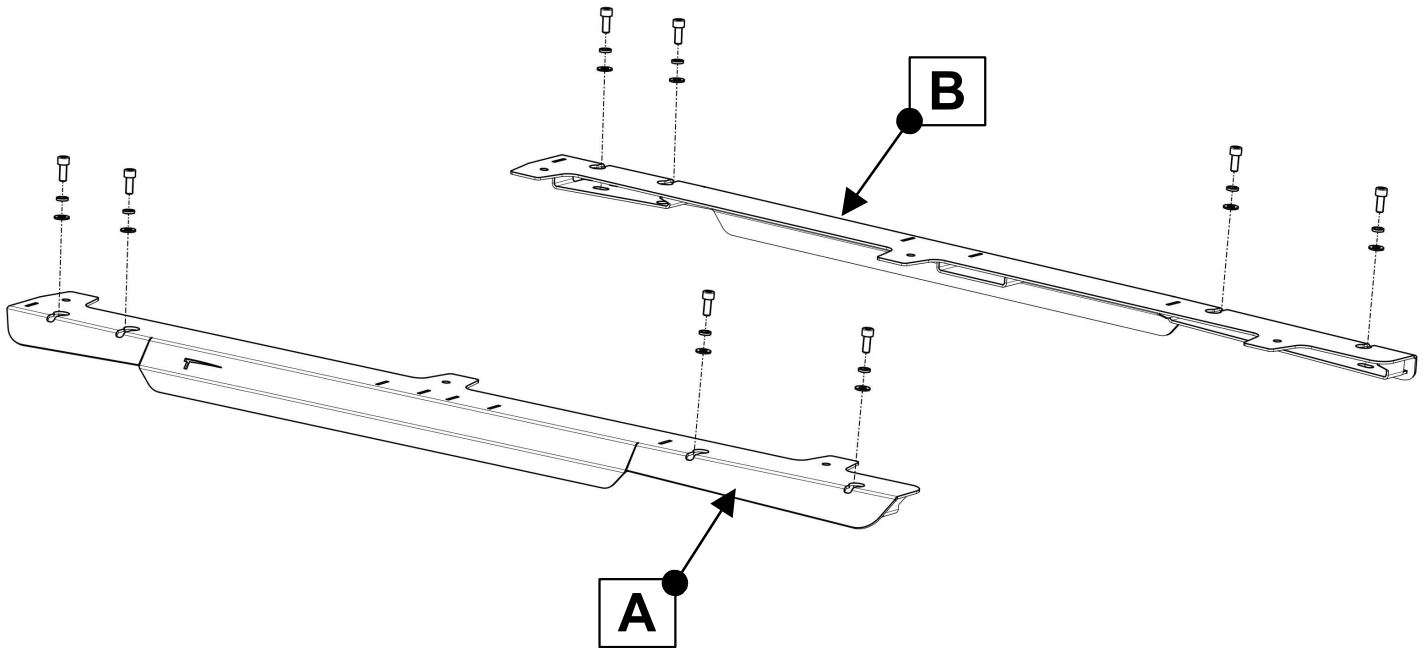

Stückliste

50-T110101

Schraubensatz

1x Halter rechts (A)
1x Halter links (B)

1x 50-SP309, RhinoRack Bot Kit (6 Stk)
1x 50-1262100, RhinoRack Pioneer 6,
1500x1240mm

1x Anbauanleitung AL2403

Bei modularer Reling:
8x Zylinderschraube M8x20
8x Scheibe M8
8x Federring M8

Bei fest montierter Reling:
6x Schraube M8 x 30
6x Zahnscheibe M8
6x Scheibe M8 x 20
6x Sperrzahnmutter M8

| Schrauben Anzugsmomente | |
|-------------------------|------------------|
| Schraubengröße | Güteklasse - 8.8 |
| M6 | 10 Nm |
| M8 | 25 Nm |
| M10 | 50 Nm |
| M12 | 87 Nm |
| M14 | 138 Nm |
| M16 | 210 Nm |

Montage bei Fahrzeugen mit modularer Reling (Bilder 1 – 6)
Installation on vehicles with modular roof rails (Pics 1–6)

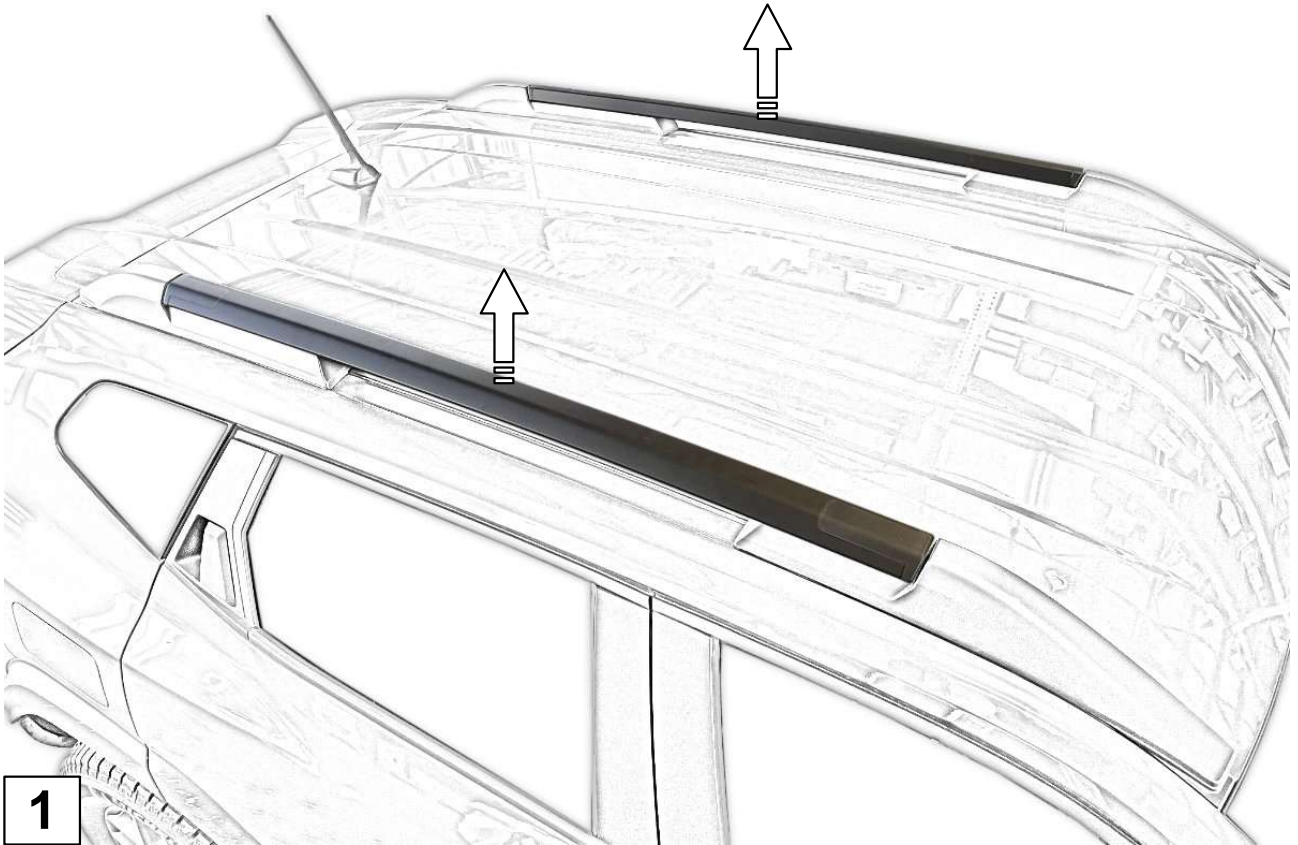

2

Schraube vorne entfernen! / Remove the front screw!

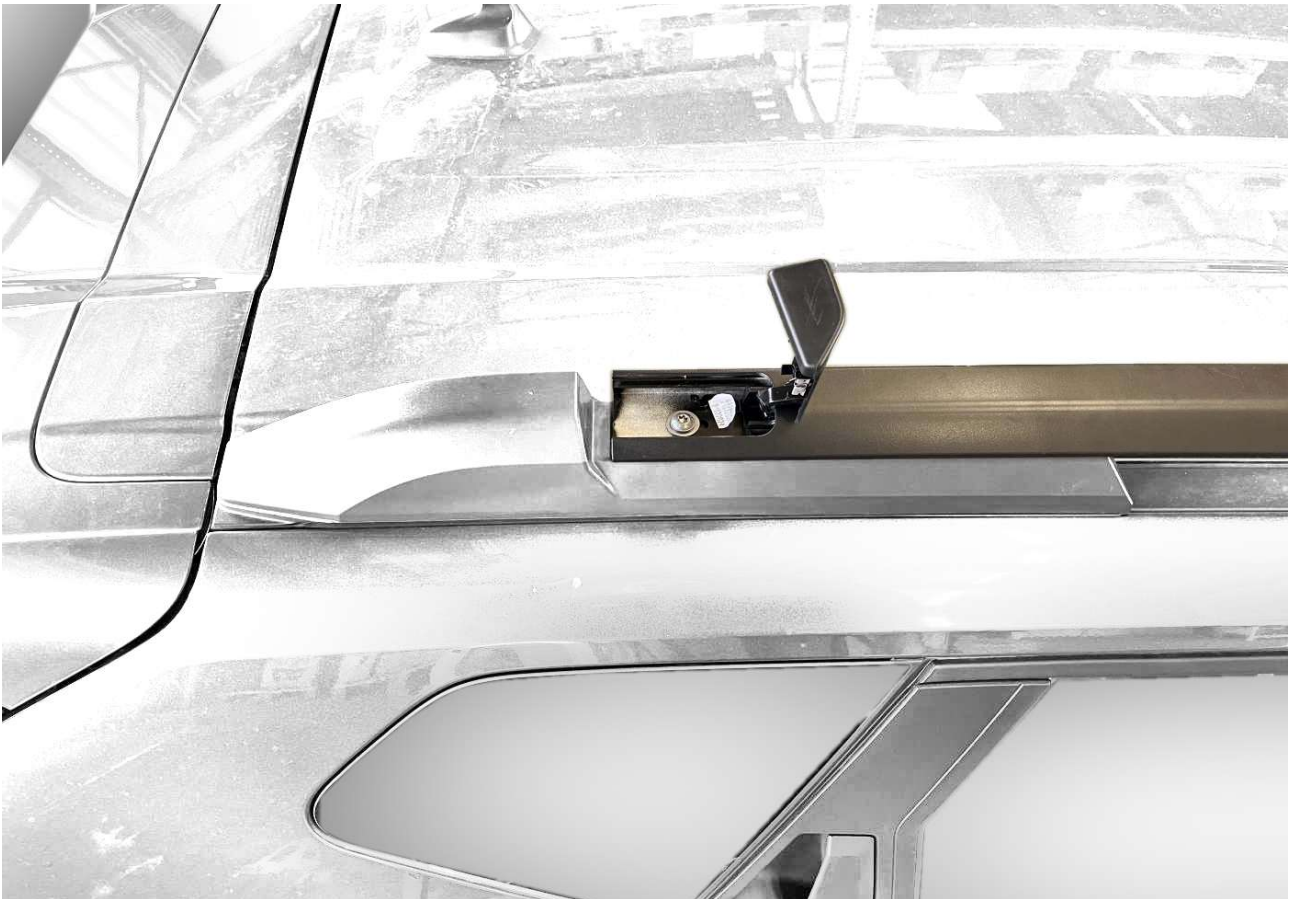

3

Schraube hinten entfernen! / Remove the rear screw!

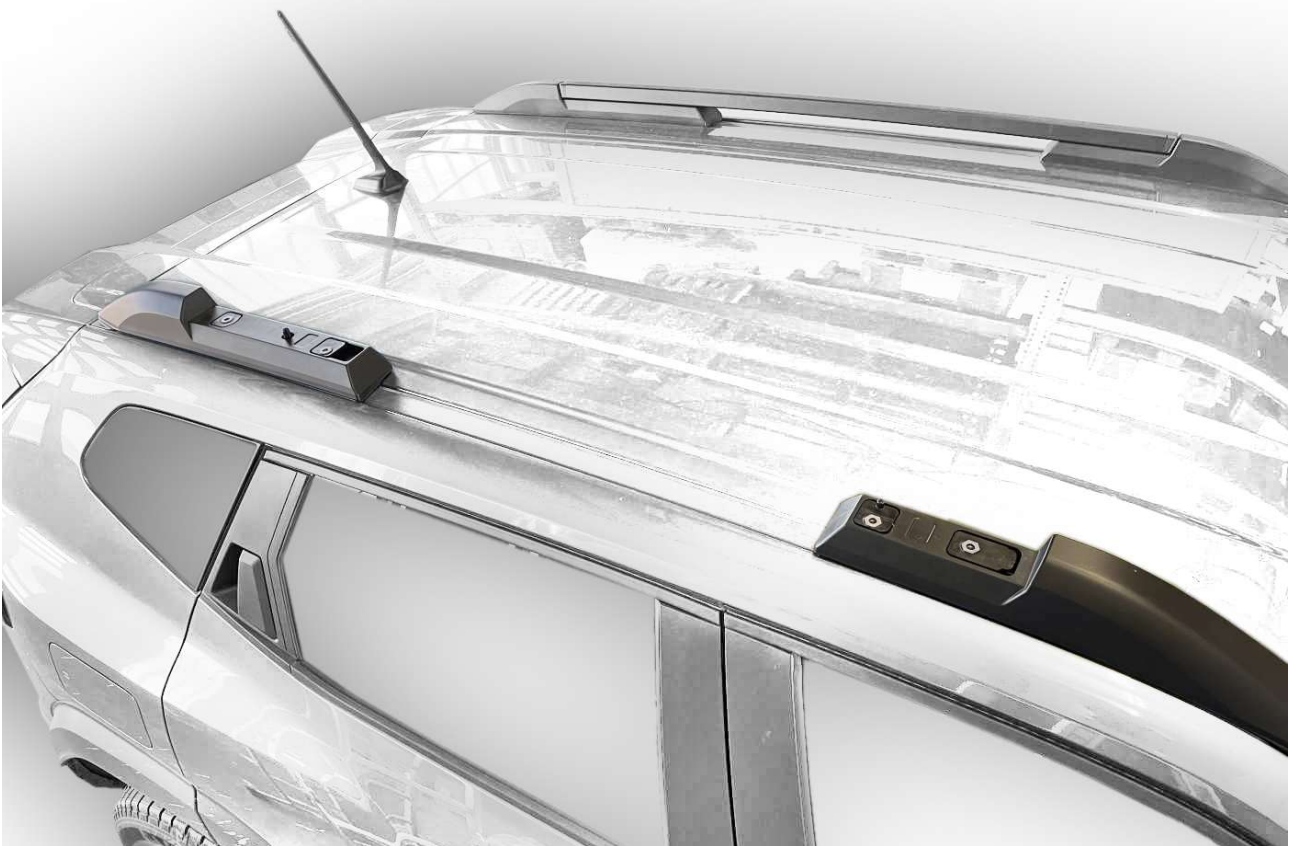

4

Reling entnehmen! / Remove the railing!

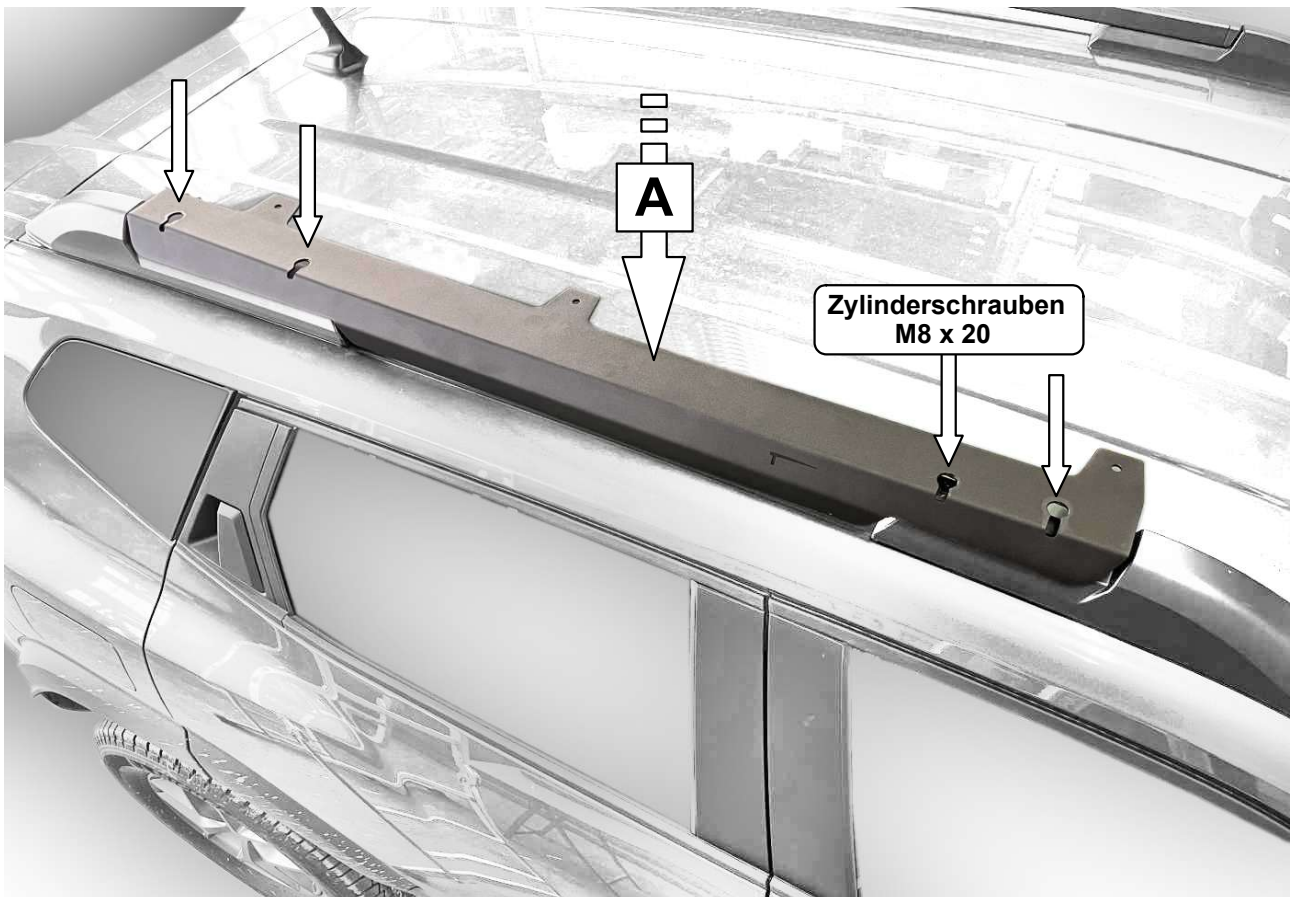

5

Halter rechts platzieren und mit den Schrauben M8x20 befestigen!
Position the holder on the right and fasten with the M8x20 screws!

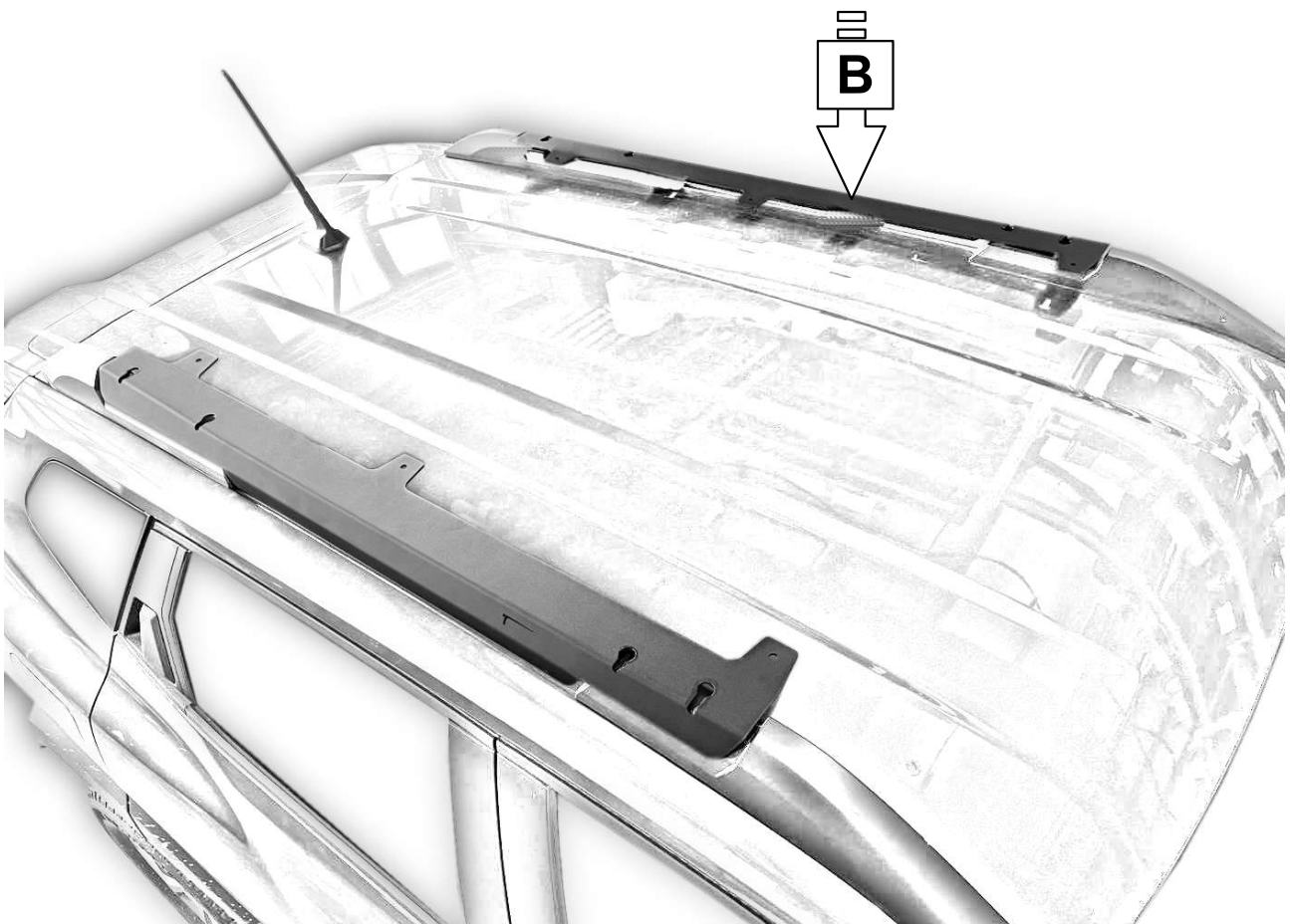

6

Die gleichen Schritte an der linken Seite / The same steps at the left!

Montage bei Fahrzeugen mit fest montierter Reling (Bilder 7 –)



7

Dachhimmel absenken! (Herstellerangaben beachten!)
Lower the headliner! (Follow the manufacturer's instructions!)



A

8

Dachreling abschrauben! / Unscrew the roof rails!

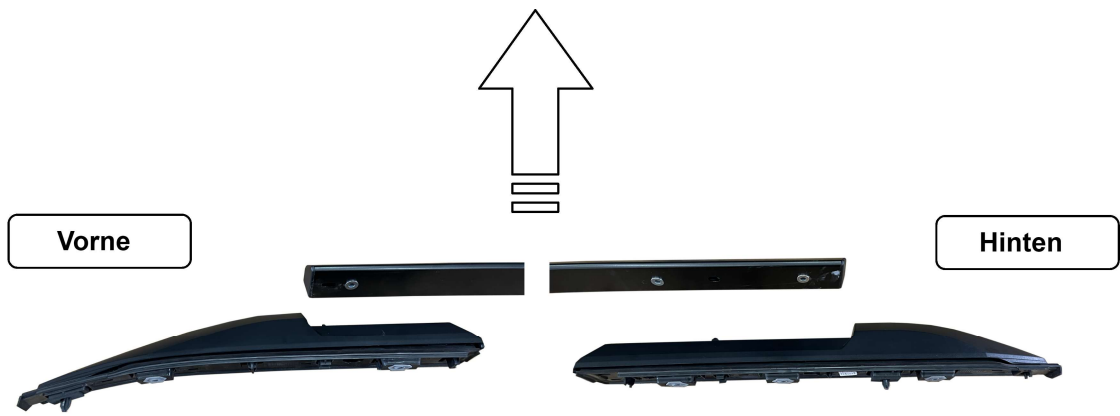

1

**Verbindungsstrebe entfernen! Das Gleiche mit der rechten Seite! /
Remove the connecting strut! Do the same on the right side!**

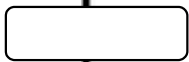

A



Bild einfügen

1

Text / Text

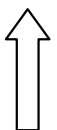
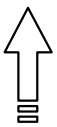
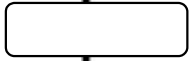

A



Bild einfügen

1

Text / Text

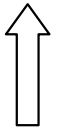
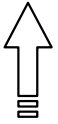
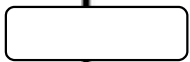

A



Bild einfügen

1

Text / Text

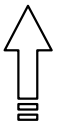
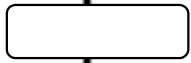

A



Bild einfügen

1

Text / Text

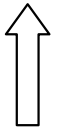
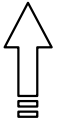
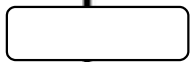

A



Bild einfügen

1

Text / Text

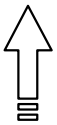
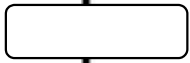

A



Bild einfügen

1

Text / Text

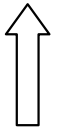
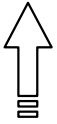
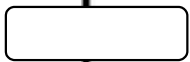

A



Bild einfügen

1

Text / Text

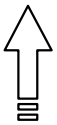
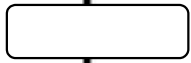

A



Bild einfügen

1

Text / Text

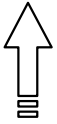
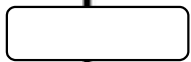

A



Bild einfügen

1

Text / Text

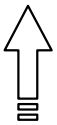
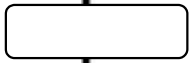

A



Bild einfügen

1

Text / Text

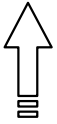
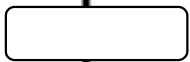

A



Bild einfügen

1

Text / Text

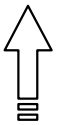
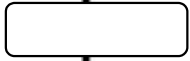

A



Bild einfügen

1

Text / Text

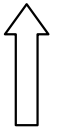
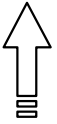
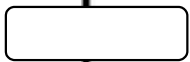

A



Bild einfügen

1

Text / Text

Hinten / rear

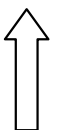

7

Einstellmaße Plattform / Platform adjustment dimensions

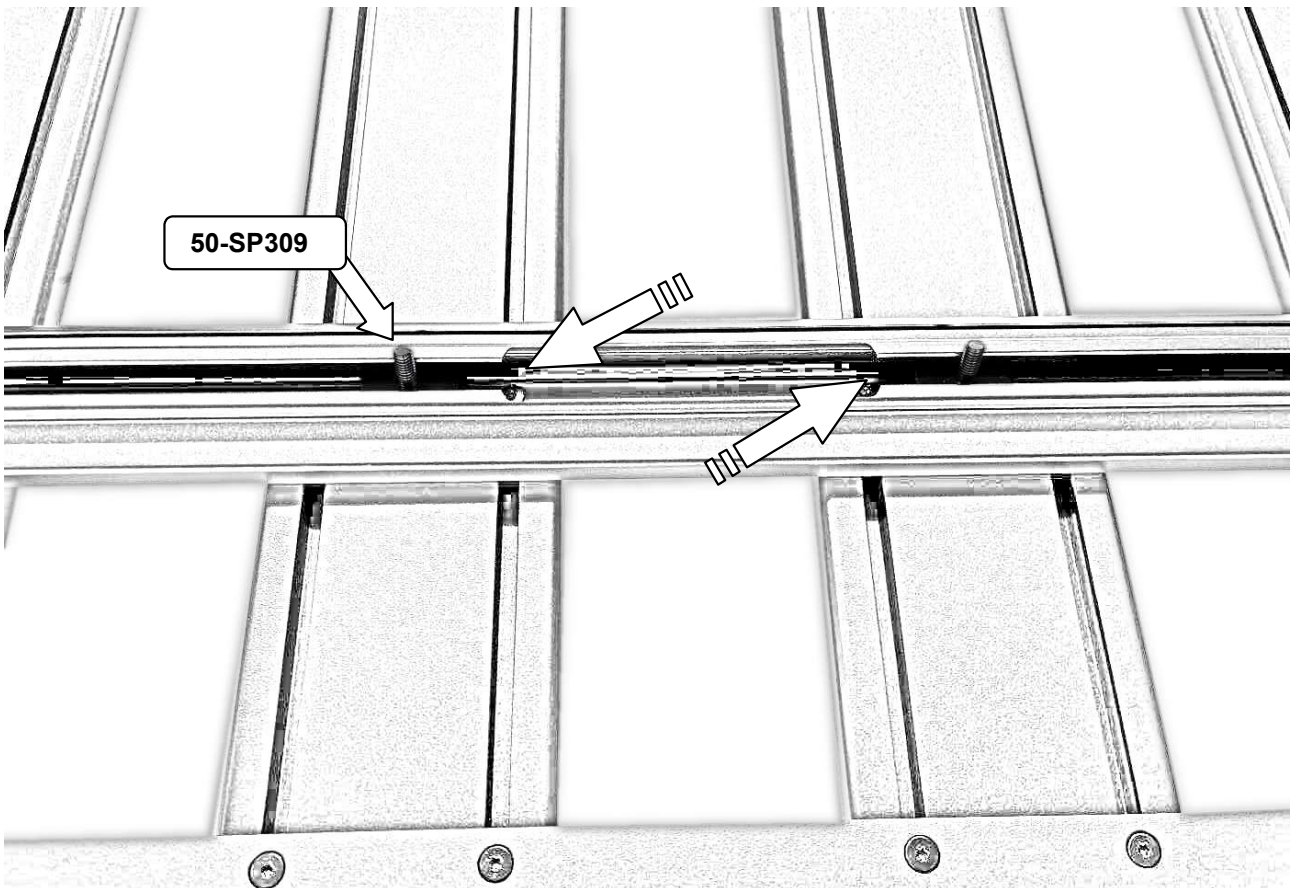

8

2x Bolzen pro Strebe einschieben! / Insert 2x bolts per strut!

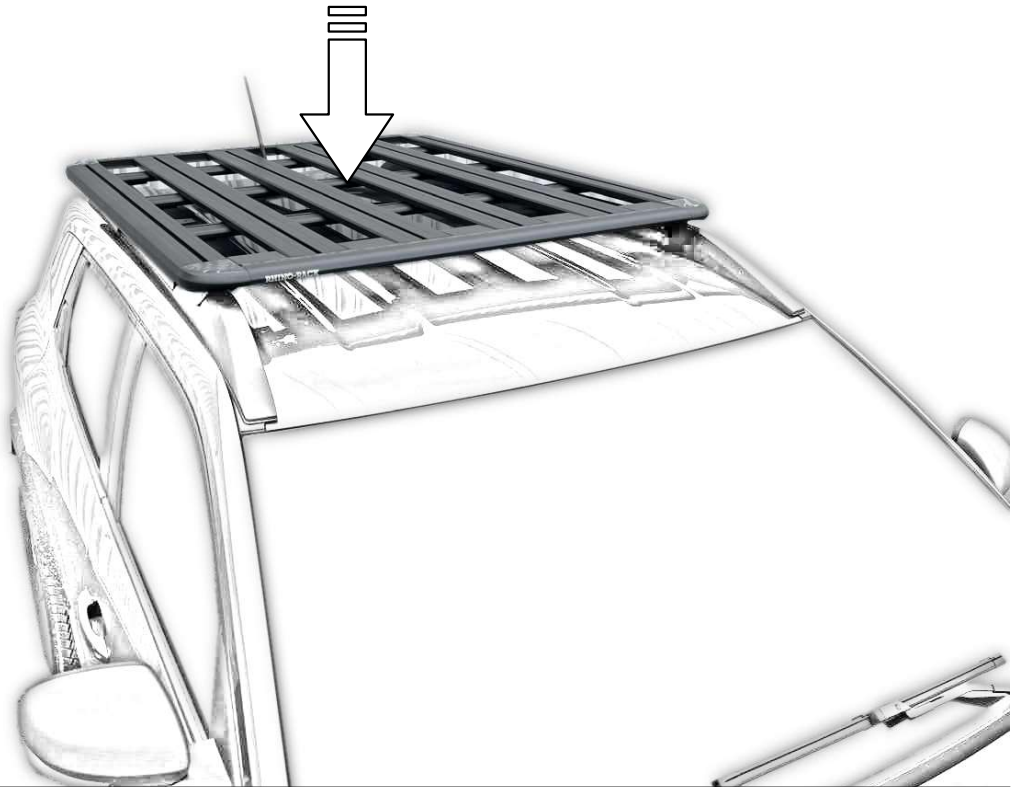

9

Plattform mit den Bolzen auf den Haltern platzieren!
Place the platform with the bolts on the brackets!

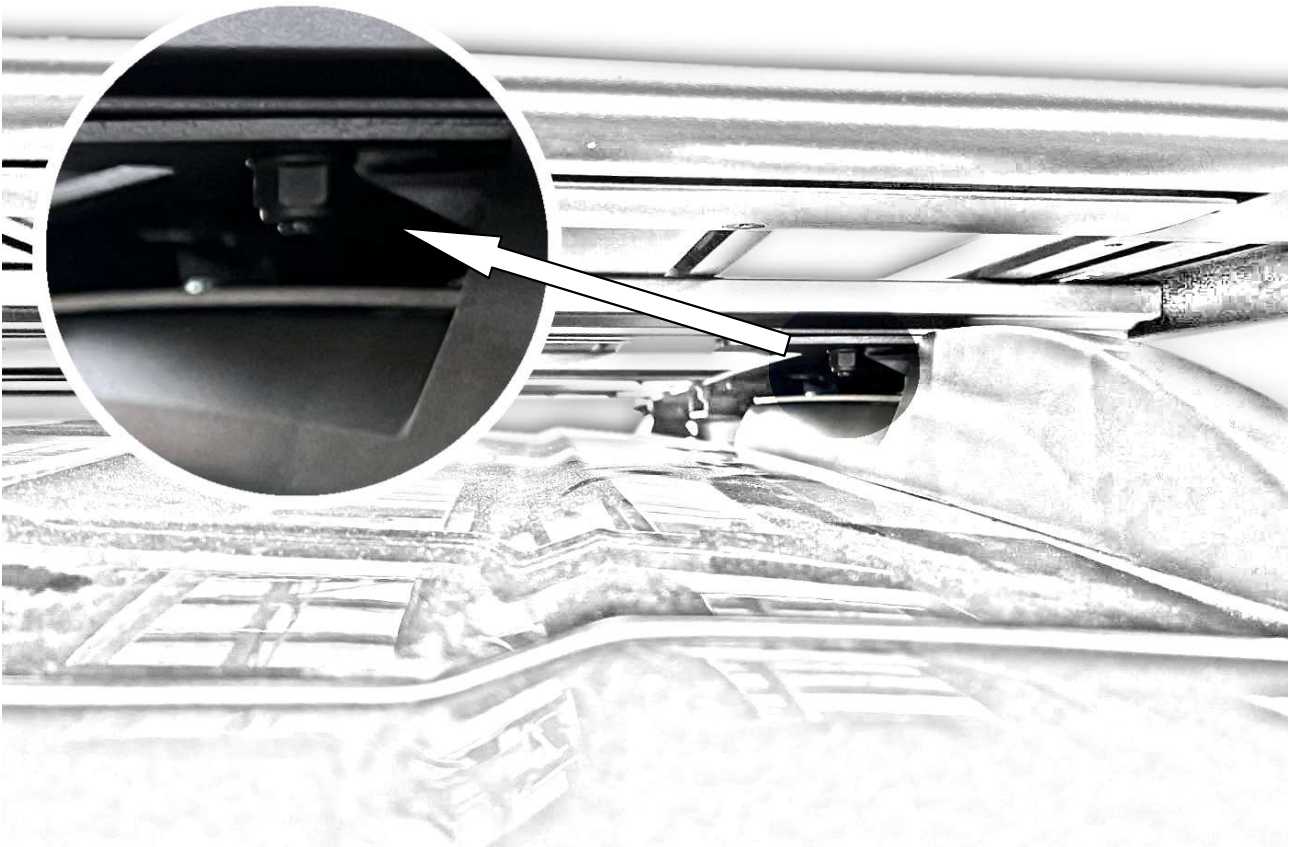

10

Plattform verschrauben! / Screw the platform!